

60 DPS-2100 1F 3S

FRONT

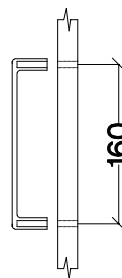

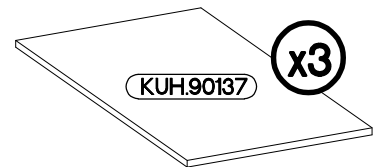

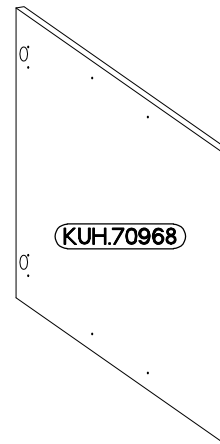
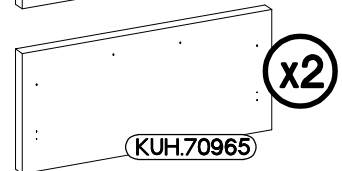
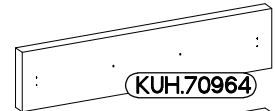
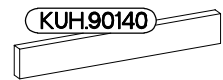
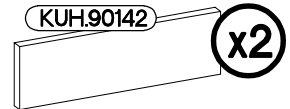
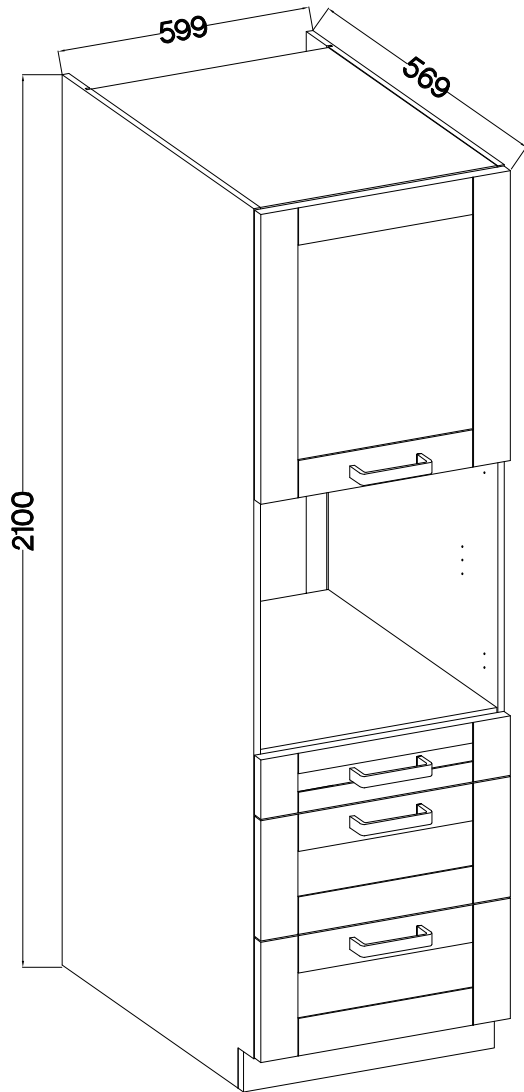
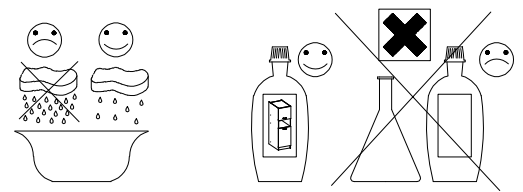
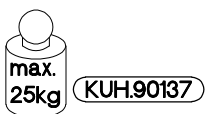

Ersatzteil Nummer	Dimension
KUH.70964	140x596x19
KUH.70965 x2	283x596x19
KUH.70968	682x596x19
KUH.90137 x3	492x442x16
KUH.90140	480x70x16
KUH.90142 x2	480x148x16

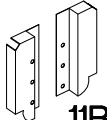
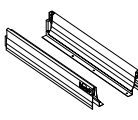
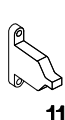
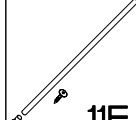

					11A	11C	11B	11D			
					3	3	2	1			
6	4	6	4	12	12	18	12	4	2	6	

ISM-KUH-01685



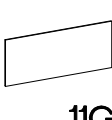

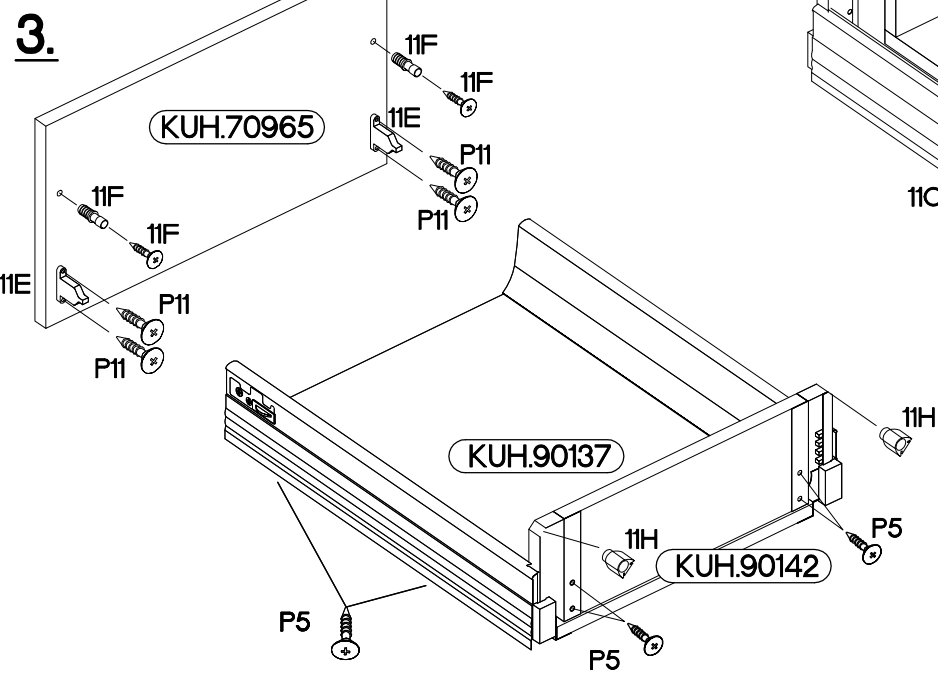
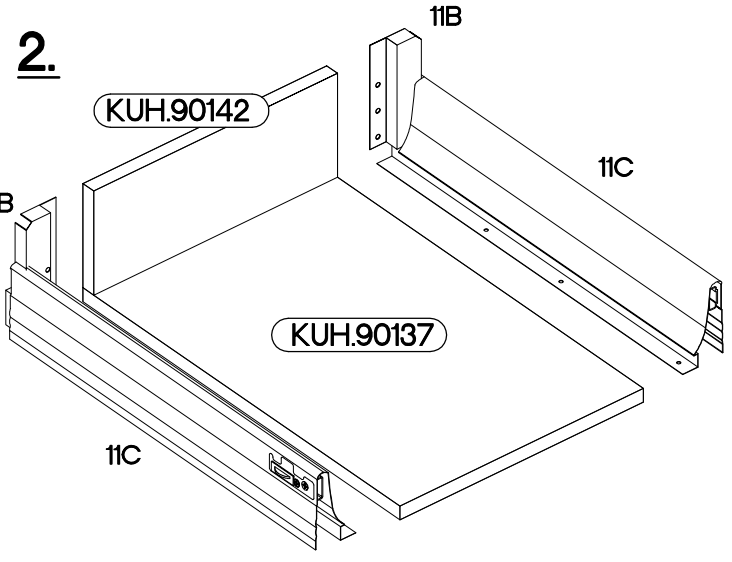
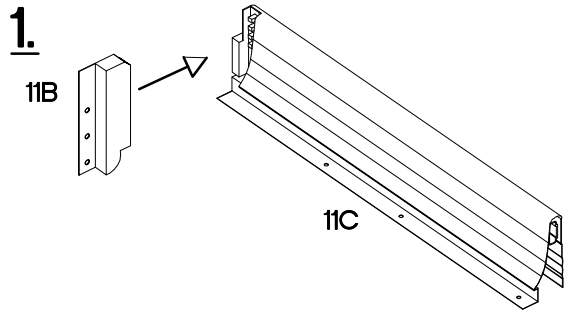
1

 11B	 11C	 11E	 11F	 11H	 P11	 P5	 11G
2	2	4	4	4	8	16	4

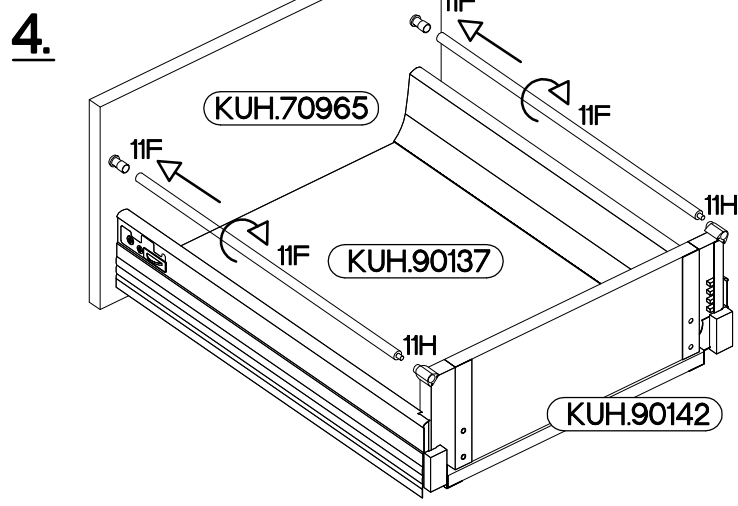

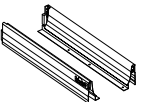

x2

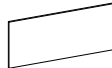

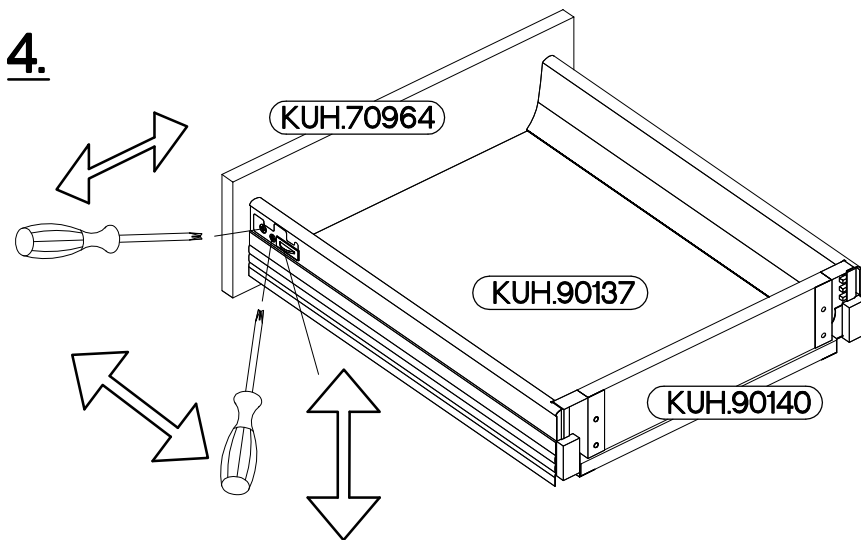
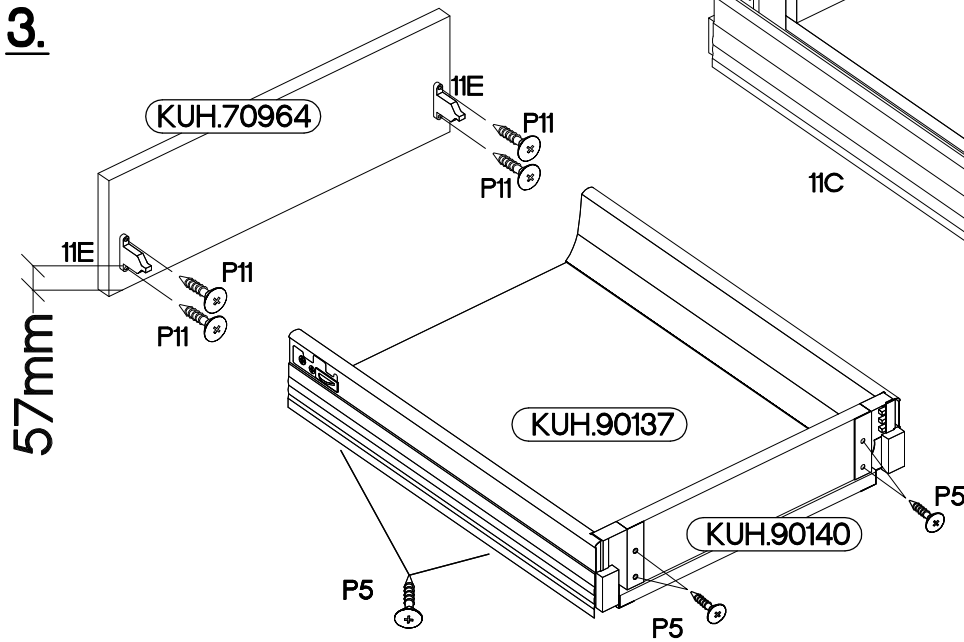
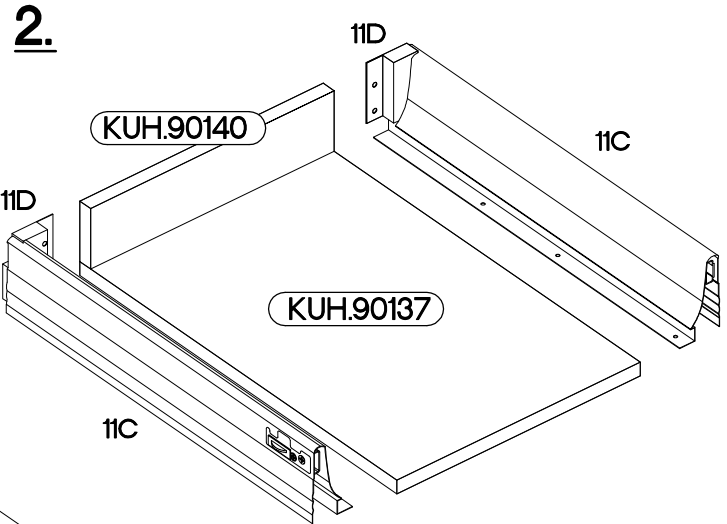
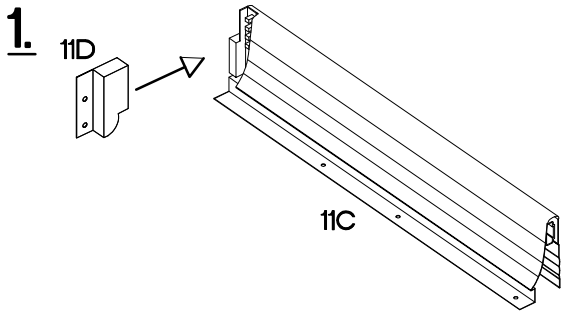
			 $\varnothing 3.0 \times 16 \text{mm}$	 $\varnothing 3.5 \times 13 \text{mm}$	
11D	11C	11E	P11	P5	11G
1	1	2	4	8	2

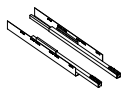

 11A 3	 +6.3x13mm M3 12	 +4.0x16mm P1 12
--	--	--

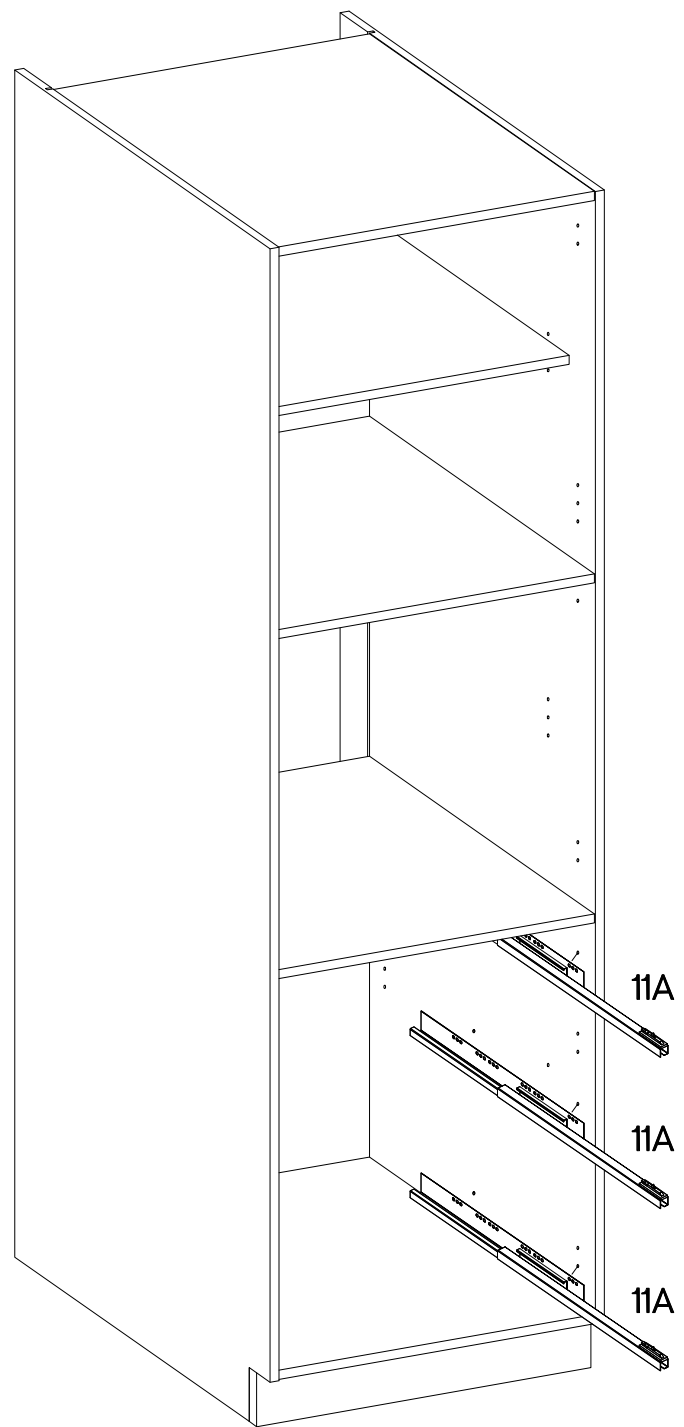
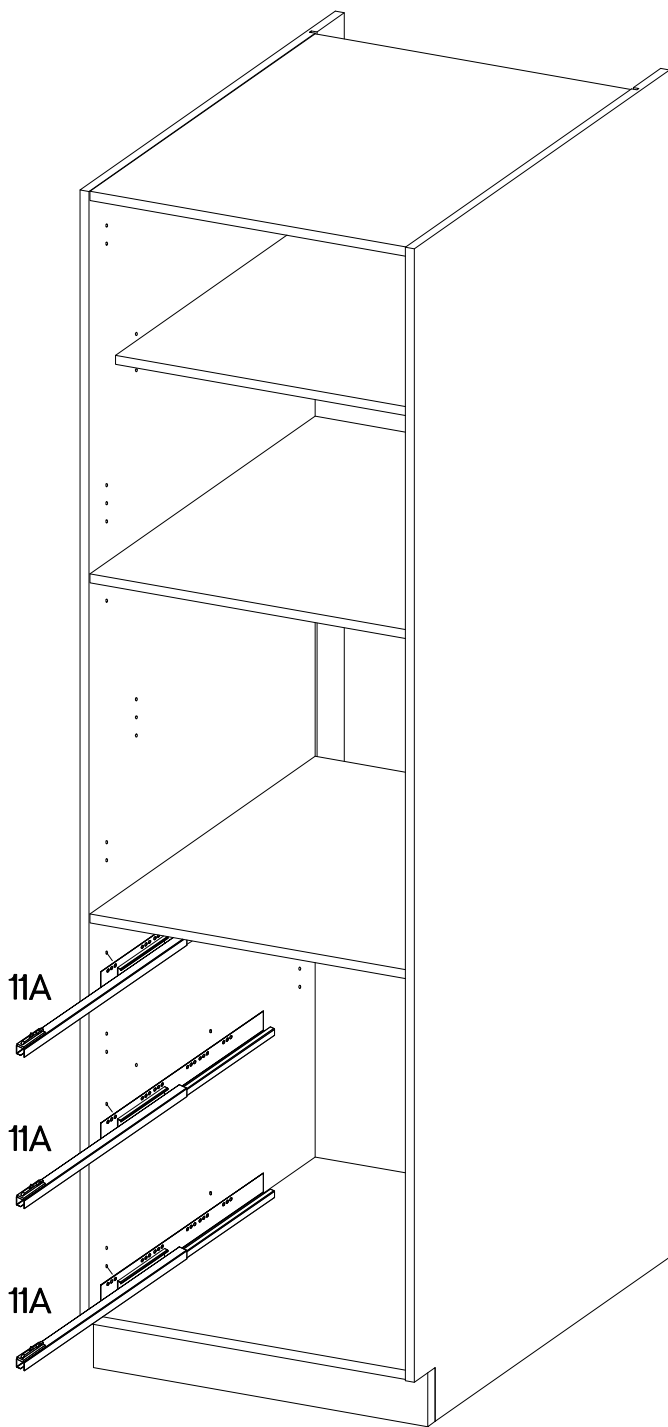
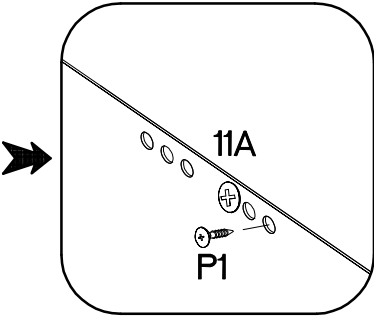
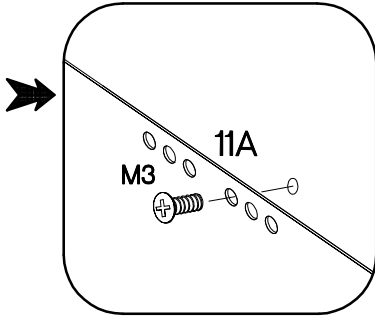
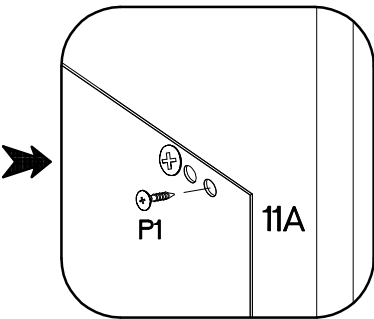
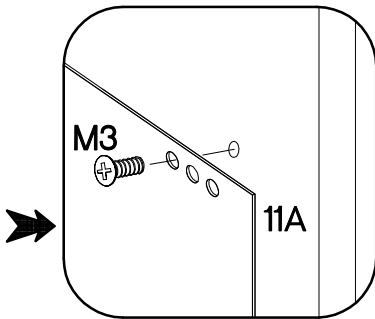
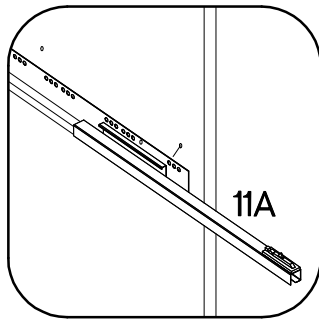

4

LEFT

RIGHT

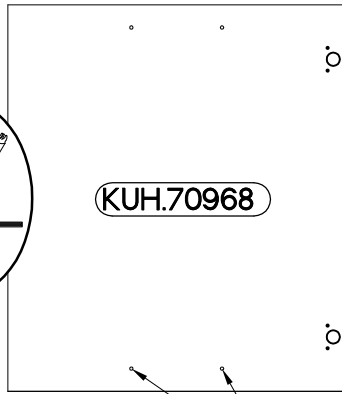
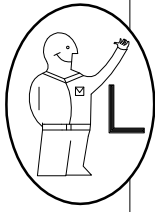

KUH.70968

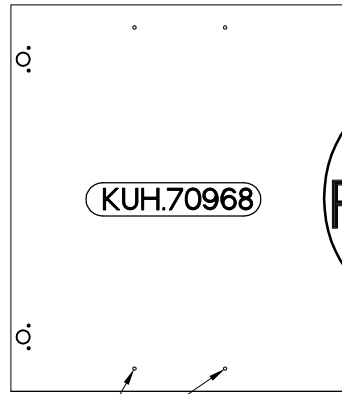

KUH.70968

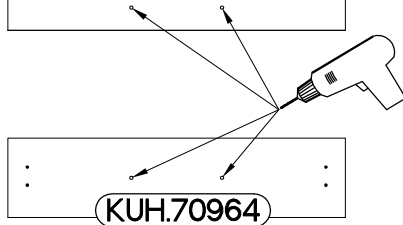
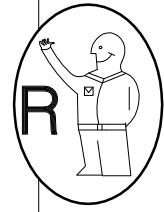

KUH.70964

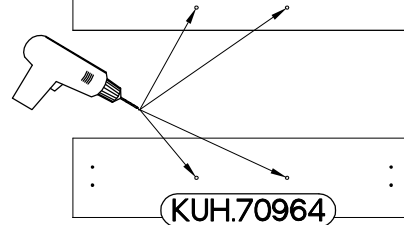

KUH.70964

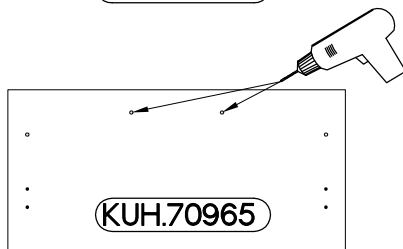

KUH.70965

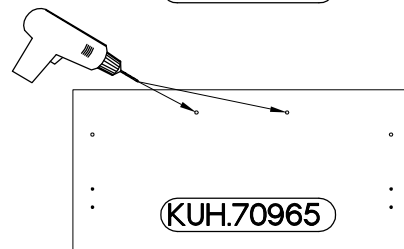

KUH.70965

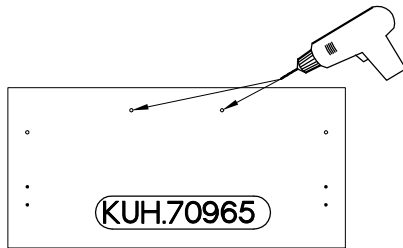

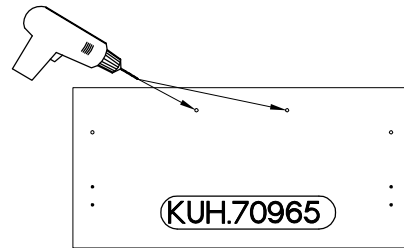

KUH.70965

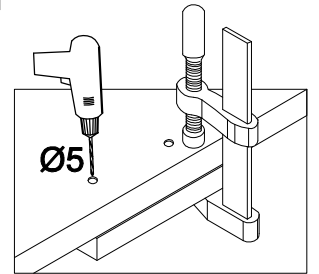
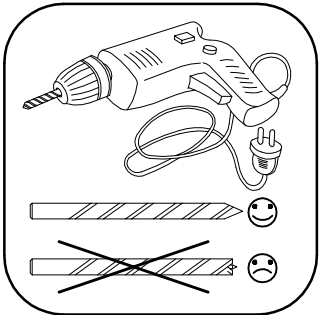

KUH.70965



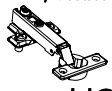

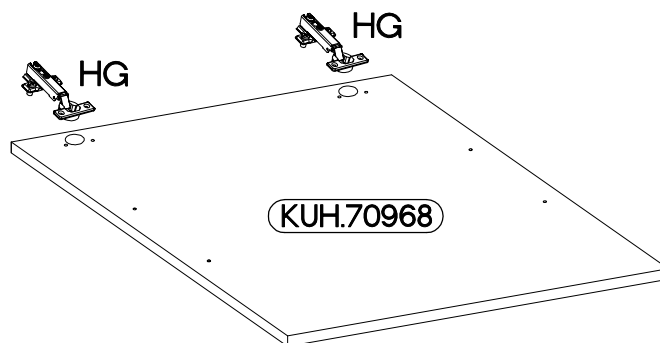

5

 †35/0mm HG 2	 †3.5x13mm P5 4
---	---

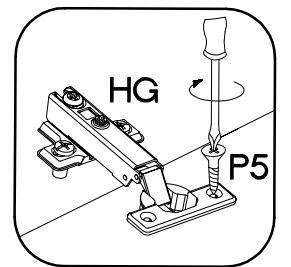

KUH.70968



L=160mm	M4x22mm	M4x27mm
		
S	U	U8
4	2	6

